

TSM

TUBULAR SPECIALTIES MFG., INC.

13011 S. SPRING ST., LOS ANGELES, CA 90061-1685 • 213/515-4801 TOLL FREE 800/421-2961 CA ONLY 800/521-7548
DESIGNER SERVICE: 7:00 A.M. TO 5:00 P.M. PACIFIC TIME • TELEX II: 910-346-6362 • FAX: 213/217-0653

460,460A, 460B,460C

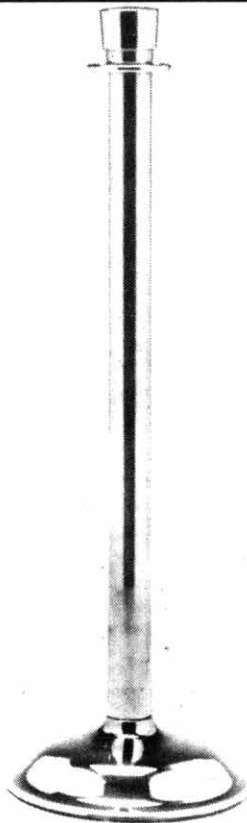

**Model # BT-460
Crowd Control Post**

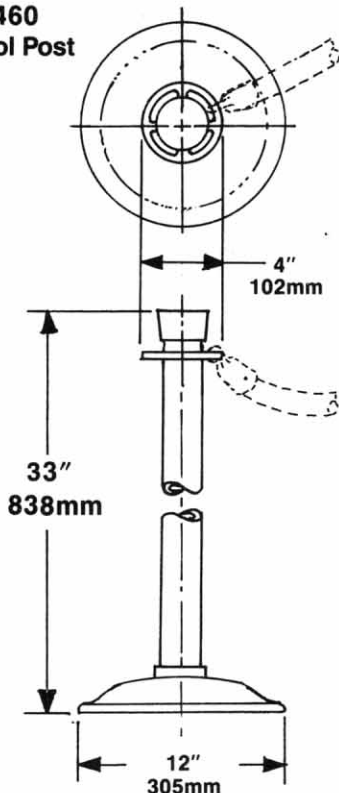

PORTABLE BRASS CROWD CONTROL SYSTEM



DESIGN CONSIDERATIONS

- TSM's Crowd Control System is recommended for use anywhere queues form, such as banks, cafeterias, and theatres. Users appreciate the fairness of the approach.
- The easy set-up and dismantling of the Crowd Control System allows instant adaptation to fluctuations in crowd size.
- The natural beauty of the bright brass finish is maintained by regular, frequent cleaning and polishing. For strictly decorative applications, clear coating is available as an option to prevent oxidation of the finish. However, the clear coating will lose its effectiveness if it becomes scratched. For further information, see Care of Metal Finishes, Reference Section B.

MODEL NUMBERS

See chart below for description of model numbers.

- BT-460
- BH-460A
- BH-460B
- BH-460C



FINISH (select one)

- Uncoated Bright Brass (standard)
- Other (additional charge; see Finish Schedule, Reference Section A, for options)



SUGGESTED ARCHITECTURAL SPECIFICATION

TSM models _____ (fill in model numbers) Portable Brass Crowd Control System from Tubular Specialties Manufacturing, Inc., Los Angeles, California, (213) 515-4801. Post and Rope Ends: sand cast of brass and machined to controlled dimensions. Tubing: 2" (51mm) O.D. Finish: _____ (select from Finish Schedule). Rope: velour at _____ (fill in length) long in _____ (select from Finish Schedule) color.



GUARANTEED PRODUCT

SEE PAGE 3 FOR COMPLETE DETAILS

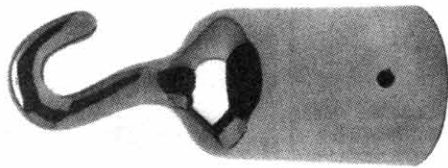

**Model # BH-460A
Hook Rope End**

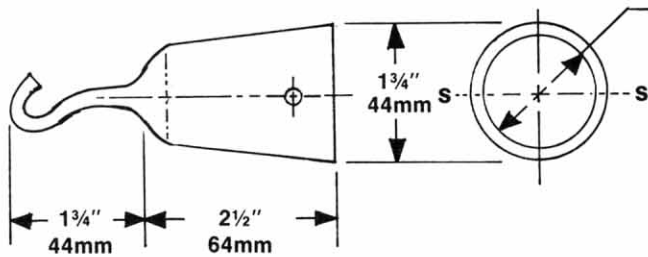

MATERIAL/WORKMANSHIP

Tubing—Brass (copper alloy—approximately 60% copper and 40% zinc) machined to controlled dimensions. Outside diameter is 2" (51mm).

Floor Flange—Brass (see Tubing), 2" (51mm) O.D., machined to controlled dimensions. A steel threaded rod connects the base flange to the post top.

Hook Rope End and Snap Rope End—Brass (see Tubing), 1- 1/2" (38mm) O.D. Screws secure ends of rope inside fittings.

Rope—Velour. Available in gold, green, blue and brown. Standard length is 7' (2134mm) between posts; shorter lengths can be custom cut (indicate post-to-post dimension only, as TSM will allow for slack). Rope fits snugly in sleeve of 460A and 460B.



DISTRIBUTION

TSM maintains a worldwide network of distributors. Call your sales representative listed in Reference Section 0 for the names of those nearest you.

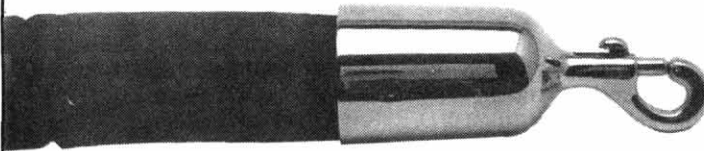

**Model # BH-460B
Snap Rope End**

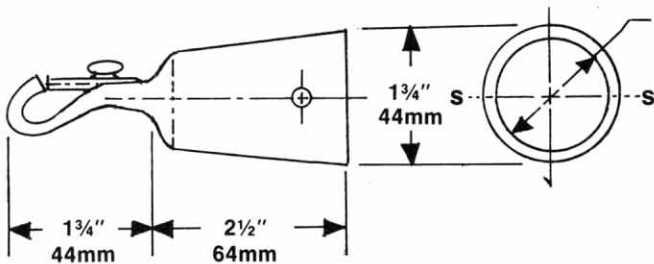

**Model # BH-460C
Velour Rope**

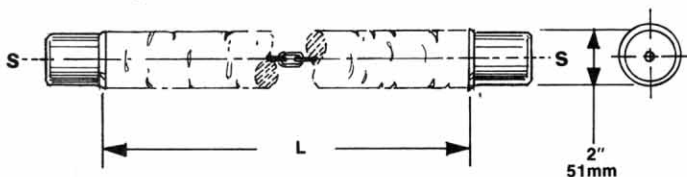

Crowd Control System Model Numbers

	1 1/2" O.D.	2" O.D.
Crowd Control Post	*	BT-460
Hook Rope End	BH-460A	*
Snap Rope End	BH-460B	*
Velour Rope	BH-460C	*

* Not Available