

Partition Hardware

Satin Finish Type 304 Stainless Steel. Contact Factory for Custom Sizes.

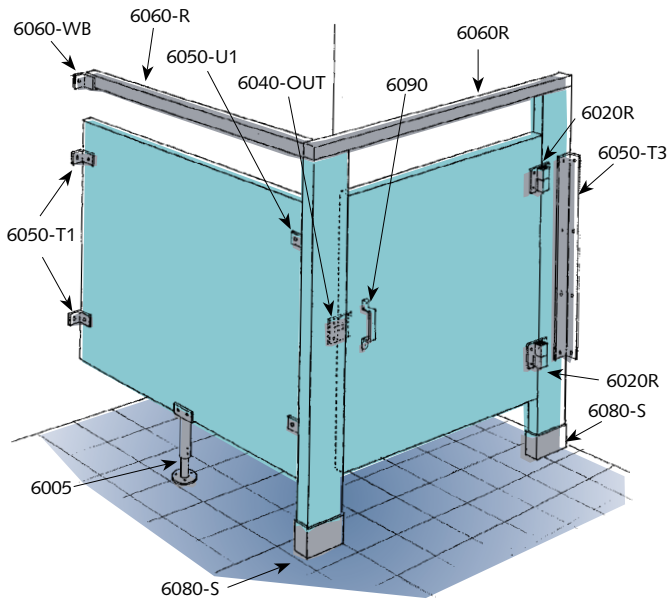

Partition Brace

Floor-mounted unit supports partition panels 1/2" to 1 1/2" thick (12.7 - 38mm).

6005 has height adjustable from 9 3/4" to 13 1/4" (248-337mm).

6005M has height adjustable from 5 1/2" to 7" (140 - 178mm).

TECH DATA

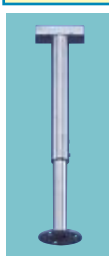

6020 Hinge

6020R = Right Hand In or Left Hand Out
6020L = Left Hand In or Right Hand Out

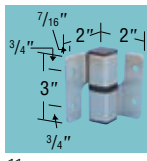

11 gauge

6030 Slide Latch

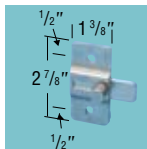

11 & 14 gauge

6040-IN Stop & Keeper, Inswing

6040-IN1 = 1"
6040-IN2 = 1 1/4"

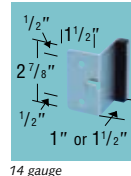

14 gauge

6040-OUT Stop & Keeper, Outswing

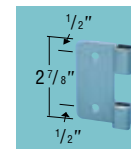

14 gauge

6070 Coat Hook & Bumper

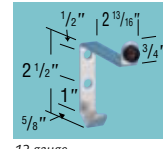

12 gauge

6090 Door Pull

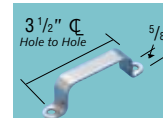

14 gauge

6095 ADA Door Handle

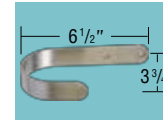

8 gauge

6060-R Headrail

6060-RS = 1" Pilaster x 10'
6060-RQ = 1 1/4" Pilaster x 10'

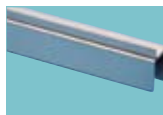

18 gauge

6060-PB Headrail Pilaster Bracket

6060-PBS = 1" Pilaster
6060-PBQ = 1 1/4" Pilaster

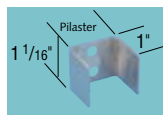

18 gauge

6060-WB Headrail Wall Bracket

6060-WBS = 1" Pilaster
6060-WBQ = 1 1/4" Pilaster

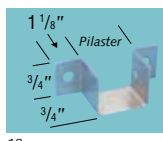

18 gauge

6050-D Double F Bracket

6050-D1 = 1 1/2" High
6050-D2 = 3" High
6050-D3 = 58" High

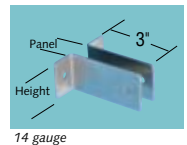

6050-F F Bracket

	Panel	
	1"	1 1/4"
Height	1 1/2" 6050-FS1	6050-FQ1
	3" 6050-FS2	6050-FQ2
	58" 6050-FS3	6050-FQ3

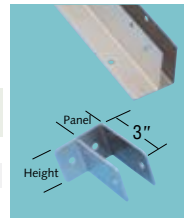

6050-T T Bracket

	Panel	
	1"	1 1/4"
Height	1 1/2" 6050-TS1	6050-TQ1
	3" 6050-TS2	6050-TQ2
	58" 6050-TS3	6050-TQ3

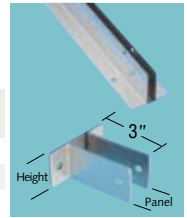

6050-U U Bracket

	Panel	
	1"	1 1/4"
Height	1 1/2" 6050-US1	6050-UQ1
	3" 6050-US2	6050-UQ2
	58" 6050-US3	6050-UQ3

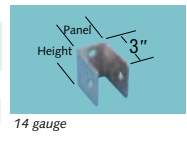

6080-A Floor/Ceiling Anchor

	Pilaster	
	1"	1 1/4"
Width	4" 6080-AS4	6080-AQ4
	6" 6080-AS6	6080-AQ6
	8" 6080-AS8	6080-AQ8
	10" 6080-AS10	6080-AQ10
	12" 6080-AS12	6080-AQ12

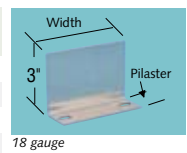

6080-S Pilaster Shoe

	Pilaster	
	1"	1 1/4"
Width	4" 6080-SS4	6080-SQ4
	6" 6080-SS6	6080-SQ6
	8" 6080-SS8	6080-SQ8
	10" 6080-SS10	6080-SQ10
	12" 6080-SS12	6080-SQ12

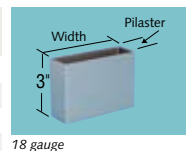

Add Suffix 'R' for Retrofit Model

Signs

- 840 Women**
- 840-A Men**
- 840-B Restrooms**

Plexiglass with polished edges.
Overall Size: **TECH DATA**
12" diameter(305 mm)



- 840-C Handicap Decal**

Pressure sensitive 6" x 6" (152mm) international access symbol. Silver on blue background.



Tactile signs comply with the signage requirements of the Americans with Disabilities Act. Durable plastic with Grade 2 Braille. Overall Size: 6" x 9" (152 x 229mm).

TECH DATA

- 840-T Women, Tactile**



- 840-AT Men, Tactile**



- 840-BT Restroom, Tactile**



- 840-CT Accessible, Tactile**

